



**SWIFT**<sup>TM</sup>  
Wind Energy System



Technical and Planning Pack

Renewable Devices Ltd T: +44 (0)131 339 2247 E: [info@renewabledevices.com](mailto:info@renewabledevices.com)

# Contents

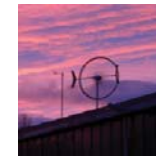

**SWIFT**<sup>TM</sup>  
Wind Energy System



Renewable Devices Ltd T: +44 (0)131 339 2247 E: [info@renewabledevices.com](mailto:info@renewabledevices.com)

3	Introduction
3	What is the Swift Wind Energy System <sup>TM</sup> ?
4	Technical Specification
5	Key Features
5	Acoustics
9	Safety
11	Installation
13	Electrical Installation
14	Electrical Schematic
15	Mounting Systems
18	Performance
21	Appendix
22	Shipping weights and sizes
23	Beaufort Scale
25	Notices

# Introduction

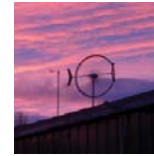

**SWIFT**<sup>TM</sup>  
Wind Energy System

As part of our mission to provide accessible renewable energy technologies, Renewable Devices Swift Turbines Ltd (RDST) have produced the world's first building mountable wind energy system capable of providing a cost effective renewable energy source for worldwide domestic, commercial and industrial use.

## What is the Swift Wind Energy System<sup>TM</sup>?

The Swift Rooftop Wind Energy System<sup>TM</sup> is the world's first aerodynamically silent building mountable 1.5kW micro-wind turbine. It has been designed specifically to meet the demands of small wind and on-site usage. The emphasis of the design process has focused on safety, reliability, ease of operation and high performance levels making it the first choice in wind power generation.

This Technical and Planning Pack is a combination of factsheets available on the website and other technical information brought together in one document designed to inform and aid the planning process for engineers and architects, through to individual end users.

This document is for guidance only. It is not intended as an installation manual and does not contain all the information required for the installation, maintenance, and commissioning of the system. The Swift<sup>TM</sup> system must only be installed by Renewable Devices Swift Turbines trained and accredited installers.



# Technical Specification

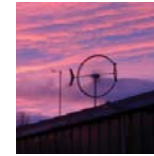

**SWIFT**<sup>TM</sup>  
Wind Energy System

Turbine Type	Upwind Horizontal Axis with Acoustic Diffuser Ring
Rotor Radius	1.0 m/ 1.04m Diffuser
Swept Area	3.4 m <sup>2</sup>
Nacelle Weight	37 kg (60kg including rotor assembly)
Start-Up Speed	3.4 m/s
Rated wind Speed	12 m/s
Rated Power Output	1.5kW
RPM at rated Wind speed	450 RPM
Generator	Permanent Magnet
Governing type	Angle furling/Dynamic brake
Governing wind speed	14 m/s
Shut-down Mechanism	Dynamic Brake
Control Included	Yes
Grid tie version	Standard Product (include inverter)
Electrical network versatility	50Hz/60Hz 220V/230V US, UK & Europe
Battery charging Version	Available on demand
Hot Water System	Available on demand
Phase configuration	Single
Mounting system available	4 mounting systems available 9 (see page 15)
Acoustic Emissions	<35dB [A] (CE Certified BS EN 61400)
Product Life	20 year design life
Turbine Class	BS EN 61400 Class 2
Warranty	2 year manufacturers warranty (return to base)

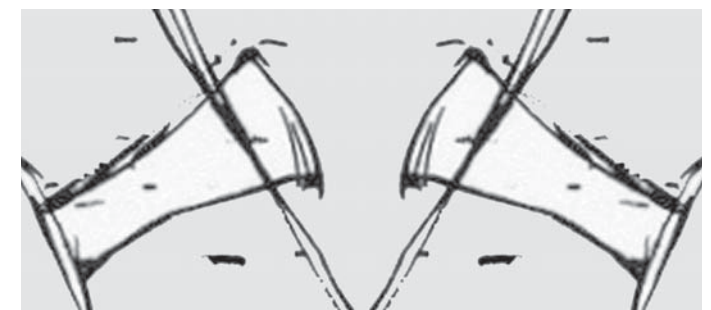

# Key Features: Acoustics

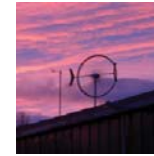

**SWIFT**<sup>TM</sup>  
Wind Energy System

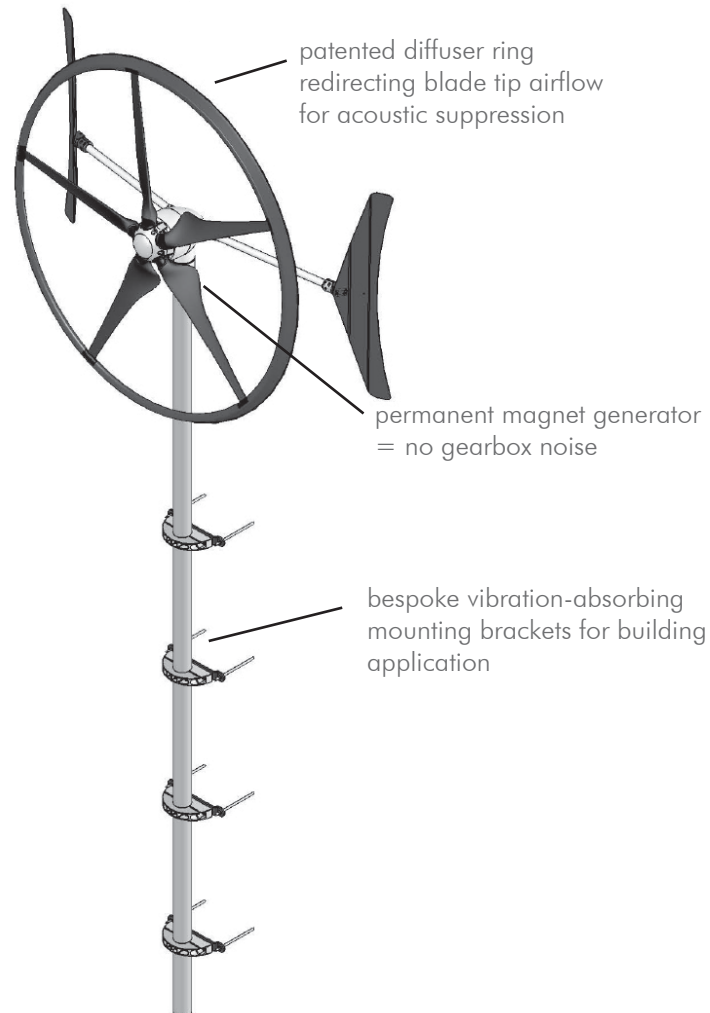

## Acoustic suppression technology

The diffuser ring, which circles the blade tips, not only gives the Swift<sup>TM</sup> its trademark circular shape but is the key to its incredible acoustic performance.

Large wind turbines make a “whooping sound” however with a significantly faster rotation speed, small wind turbines often sound more like a chainsaw. The noise is caused by the high speed at which the wind flows from the end of the blades at a single tip point.

The Swift<sup>TM</sup> is aerodynamically different because the system’s unique patented sound suppression system, the diffuser ring, redirects the air at this critical point, forcing it to exit the blades over a much larger surface area and over a far smoother course. By shedding the turbulent air currents that flow from the blade tips (and create sound), the potential for resembling a chainsaw and any unpleasant noise is removed.

## Why it is important

Acoustic performance is a critical requirement for wind systems which will be installed in inhabited areas, and has traditionally been a concern in small wind energy.

By resolving this issue with the development of a sound suppression system, and patenting the diffuser ring design, Renewable Devices have not only received recognition of the strength of the unique design but also ensured that the Swift<sup>TM</sup> remains to be the quietest horizontal axis micro-wind turbine available globally.

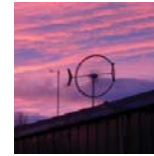

## Measuring acoustic performance

The measurement of the acoustic properties of the Swift™ wind turbine in accordance with the British Wind Energy Association's Guidelines and British Standard (BS 61400) require measurement of the equipment during periods of varying wind speeds. As standard, the final turbine sound pressures are calculated based on the difference that the turbine has on the background noise made by the wind itself.

For most turbines which operate above the background noise this system is adequate. However, when measuring the average acoustic output over 1 minute of the Swift™ at 2.5m below the hub of the turbine, the operation of the turbine is audibly indistinguishable from ambient background noise of the wind over all wind speeds.

Renewable Devices can guarantee that, when measured to the British standard during low winds (and therefore low background noise) the turbine does not exceed 35dbA across all frequencies. During high winds the turbine remains below background noise in the urban environment.

## The Swift™ is virtually silent when in operation.

Please note: near-silent operation refers to the noise made by the rotor. The Swift has no gearbox meaning there is no mechanical noise however the rotor is so quiet you may be able to hear the generator hum, similar to that made by a fridge.



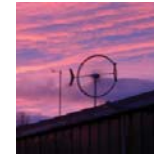

## Sound Pressure Levels at 8 m/s windspeed to BS EN 61400

This graph shows sound levels of the turbine an individual could expect to encounter at various distances in relation to background noise. Sound levels are slightly increased in the built environment when compared to a more rural setting due to density of buildings reflecting and ever so slightly amplifying the sound.

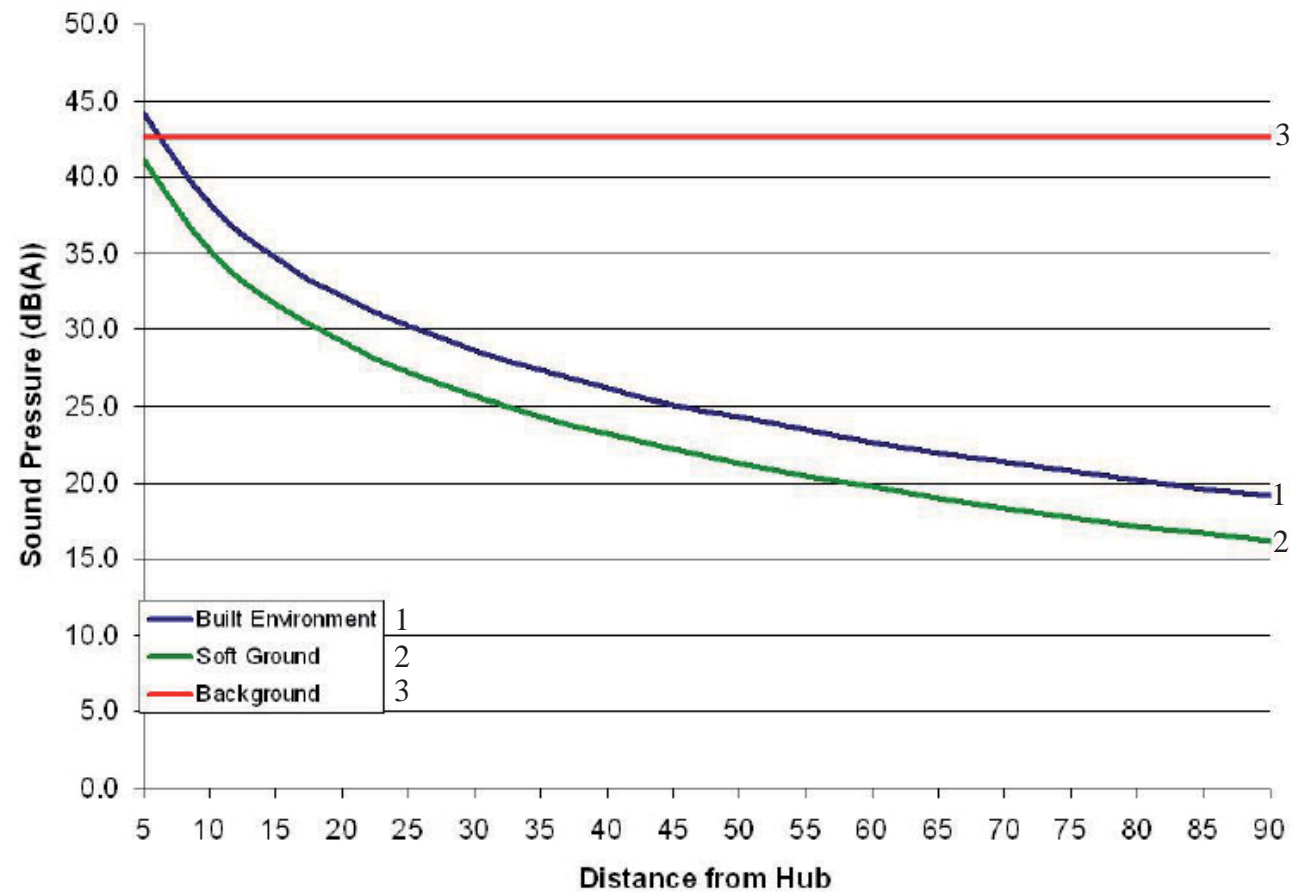

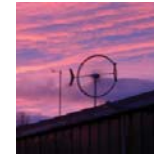

## Sound pressure levels indoors

Windows insulate sound from the outdoors, you should account for this when considering where to place your turbine.

For example : The noise heard from a turbine installed on a home with double glazing will be up to 10dB quieter indoors. The table below shows the noise reduction you can expect for sound levels indoors.



## Sound Insulation of windows

### Particular Window Description

### Sound Insulation (average 100 Hz to 3150 Hz) in dB (amount deducted from outdoor noise levels)

Ventilated window, staggered openings not more than 5% of the area	Up to 15
Ordinary single openable window closed but not weather stripped, <4mm glass	Up to 20
Single fixed or openable weather stripped (closed) window, with 4mm glass	Up to 25
Fixed single window with 10mm glass	Up to 30
Thermal double glazing units have the same acoustic performance as single glazing of the same total weight. Thermal glazing usually has an air gap of <25mm	Up to 30
Double openable windows*, weather stripped 100mm air space, one window 4mm glass, the other 6mm glass	Up to 35
Double openable windows*, weather stripped 150mm to 200mm air space, one window of 4mm glass the other window at least 6mm glass	Up to 40
Double window*, outer light fixed in resilient mounting, inner light fixed but removable, 200mm or more air space, absorbent reveals, 6mm and 10mm glass	Up to 45

\*All double windows are taken as fitted in separate frames

Source: British Standard Code of Practice for Sound Insulation and Noise reduction for Buildings BS 8233 : 1987



# Key Features: Safety

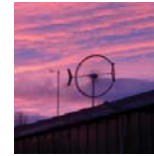

**SWIFT**<sup>TM</sup>  
Wind Energy System

The Swift<sup>TM</sup> turbine is mechanically and electrically safe. Its design was independently verified for structural, electrical and grid monitoring safety by NAREC (New And Renewable Energy Centre) and the Energy Savings Trust. The Swift<sup>TM</sup> was designed to withstand wind velocities of a hurricane (for more information on wind velocities see the Beaufort scale in the Factsheet: Performance).

## Structural and Electrical Safety

The Swift<sup>TM</sup> turbine is designed to meet and exceed all of the structural and electrical safety constraints required by the current UK and international safety requirements (see below for BS Standards).

## Safe Control System

If the National Grid experiences a fault, for example a power cut, the Swift<sup>TM</sup> inverter will automatically stop the turbine operation. If high winds are experienced there are some fail-safe safety techniques programmed into every Swift<sup>TM</sup> system. They work as follows:

### Furling:

On experiencing high winds the turbine furling system will kick into action rotating the turbine out of the oncoming wind slowing the rotor down.

### Electronic Brake:

If the high winds keeps on increasing, the control system will be slowed down using an automatically controlled electronic brake.

### Over-Speed Brake:

If storm conditions ensue, or when the first two control systems are not sufficient, the turbine will automatically switch itself off.



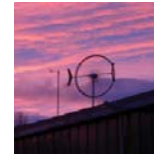

## Emergency Management

Rest assured our engineers have planned for all possible eventualities such as:

### Shock

Collision with an unidentified flying object (UFO); such an event could damage the system. Therefore if a violent shock occurs a sensor inside the nacelle will automatically stop the turbine operation until manual reset of the control system after a visual inspection.

### Abnormal Unbalancing

If for some reason the system becomes unbalanced a second safety system will detect any violent vibrations and lock the turbine until manual reset of the control system after a visual inspection.

### Compliance

#### Regulations and Safety Standards\*

**ISO EN 61400-2:2006** Design Requirements for Small Wind Turbines:

This document deals with safety philosophy, quality assurance, engineering integrity and specifies requirements for the safety of Small Wind Turbines including design, installation, maintenance and operation. Its purpose is to provide the appropriate level of protection against damage by hazards from these systems during their planned lifetime.

The next two refer specifically to electrical safety requirements:

Renewable Devices hold certificates for both the **G83/1** and **G59/1** certified by the NAREC.

**BS 7671 - Requirements for Electrical Insulation** (IEE Wiring Regulations 17th Edition)



\* BS stands for British Standards. Standards are codes of best practice that improve safety, efficiency, interoperability and facilitate trade. Engineers use them as an important tool within all aspects of their work from design through to safety analysis.

# Key Features: Installation

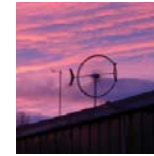

**SWIFT**<sup>TM</sup>  
Wind Energy System

## RDST Installer Network

To ensure that every Swift<sup>TM</sup> Turbine is installed in an appropriate location, to our specification and by trained professionals who will work with the highest level of customer service, the Swift<sup>TM</sup> must be installed by a Renewable Devices accredited installer.

In order to locate your local installer, please contact us on +44 (0)131 339 2247 or e-mail [info@renewabledevices.com](mailto:info@renewabledevices.com).

We do not allow the Swift<sup>TM</sup> to be sold as a DIY product. If you do not have your system installed by an accredited installer, we will be unable to verify the quality of the installation and regretfully will therefore be unable to cover the system under warranty.

## What To Expect

All Swift<sup>TM</sup> installers have been trained by Renewable Devices. We are in regular communication with all our installers; we carry out quality management inspections and are confident that they will provide you with a professional service and treat you and your home with the utmost respect.

Your installer will require access to your home and clear, unobstructed access to the distribution board area for installation of the inverter.



## Timescale

Installation of the Swift<sup>TM</sup> Wind Energy System will typically take a two person team two days to complete. This may vary depending on the property; your installer will be able to advise you if there is likely to be any additional works after visiting your property.

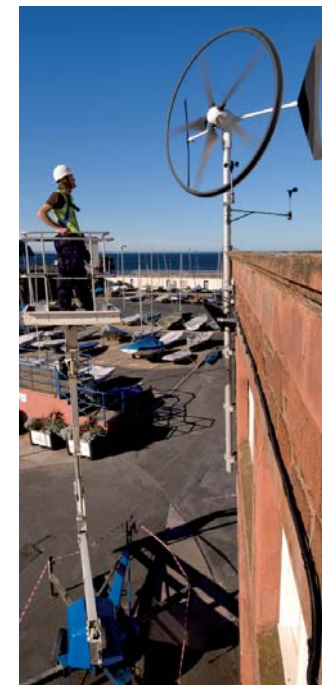

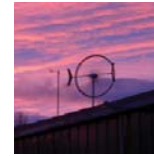

## Installation

Our SWIFT can be installed by any competent engineering company, the procedure is similar to that of a PV installation. We recommend you use a company that have experience in installing small wind turbines.

There is a list of competent installers on the MCS website for the UK.

## Step-By-Step Installation - (see our website downloads for more detail)

1. Transportation and receipt of the Swift<sup>TM</sup> Rooftop Wind Energy System
2. Preparation of walls and installation of mounting brackets or, for freestanding models, preparation of ground and installation of pole
3. Installation of grid tie inverter or battery bank
4. Installation of Swift<sup>TM</sup> turbine
5. Electrical connection
6. Testing
7. Commissioning

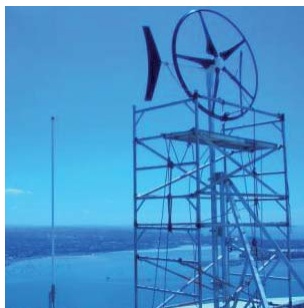
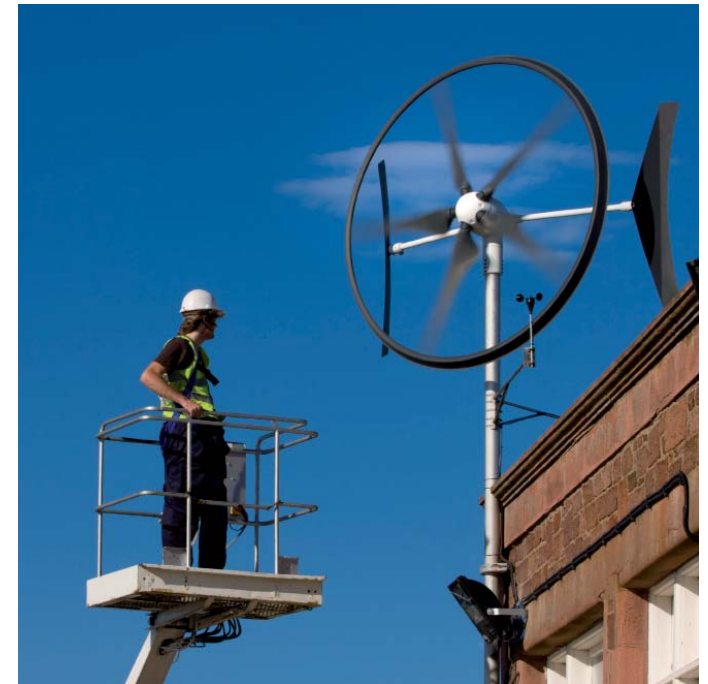

## Becoming A Swift<sup>TM</sup> Installer/Distributor

If you are interested in finding out more about becoming an accredited installer of the Swift<sup>TM</sup> Wind Energy System, please contact us:

Installations Team  
Renewable Devices Ltd  
Building 10, Aeromarine House  
Turnhouse Road  
Edinburgh EH12 9DN

info@renewabledevices.com  
+44 (0) 131 339 2247

# Key Features: Electrical Installation

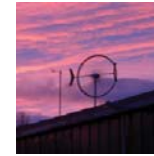

**SWIFT**<sup>TM</sup>  
Wind Energy System

The Swift<sup>TM</sup> rooftop energy system has been specially designed to be connected to the national grid in order to export either all of the energy or the excess energy generated as discussed below:



## On Site Generation

The Swift<sup>TM</sup> rooftop energy system is installed on the side of your utility meter within your house or building's electrical system. Your house automatically uses the energy from the Swift<sup>TM</sup> when it is available or electricity from the national grid as normal. You will save on any energy that you would have bought from the grid but instead have generated yourself through your Swift<sup>TM</sup>. In addition the existing ROCs (Renewable Obligation Certificates) and new feed-in tariffs will give you an income based upon ALL of the renewable energy that your Swift<sup>TM</sup> generates whether you use it or not! Any energy you do not use, and goes onto the grid, may also provide you with a further additional income depending on your utility.

## Alternative Systems

Bespoke battery charging systems, water heater systems and power from water purification systems are available on demand.

Please contact us for more information on these bespoke systems.

# Key Features: Electrical Schematic

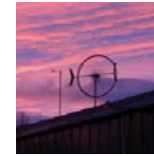

The Electrical schematics presented below correspond to the standard 100% export system. Only a few details will vary in an excess export setup.

The Swift™ generates electrical energy from the wind and sends it to your house as DC electricity (this makes it the same, and compatible with solar energy systems).



## Swift™ DC isolator

The DC Isolator is a 3 function in 1 device. It allows you to: break, isolate and reset the turbine

## The Inverter

The inverter transforms the variable DC current into a stable AC current and feeds it into the national grid.

## AC isolator

The AC isolator allows you to isolate the Swift Inverter from your house and the national grid.

## Energy Meter

The energy meter measures the energy generated by the wind turbine.

## MCCB/MCB

The MCCB (Moulded Case Circuit Breaker) is the customer's main circuit breaker. It is a standard protection which will disconnect the SWIFT from the electricity supply if a critical fault occurs.

## Legend

- COM: Communication with embedded control system
- DC+: Positive DC line
- DC-: Negative DC line
- L: AC Live
- L1,L2,L3: National 3 phases
- N: AC Neutral
- PE: Earthing
- SWA: Steel Wire Armoured Component

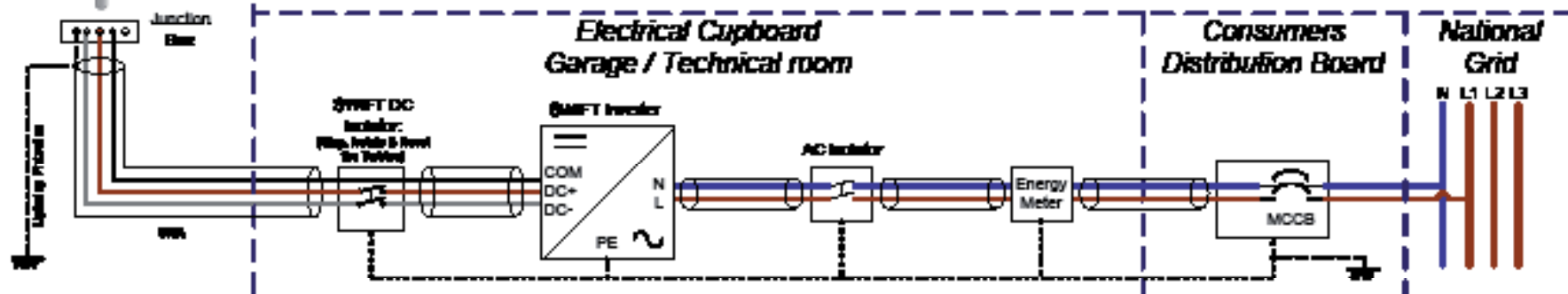

# Key Features: Mounting Systems



## Standard Wall Mounting System (SWMS)\*

The standard wall mounting system can be fitted to solid, brick and block, double skin brick, and steel framed wall types where the thickness of the wall is in excess of 250mm. **The structural suitability of the building must be ascertained prior to the installation.**

The mast will be fixed to the side of the building with four vibration isolating brackets, attached with a Fischer resin anchor system.

### Kit (supplied in addition to Swift™ Turbine)

- 5m aluminium pole
- 4 sets of fixing brackets



## Flat Roof Stand Mounting System (FRMS)\*

The flat roof stand has been designed specifically for the Swift™ and can be used on horizontal building surfaces. This mounting system is most often used in commercial and industrial installations where multiple turbines are being sited together. The installation of this stand is site-specific and may require additional engineering work to be carried out in order to assess/ensure the structural suitability of the building.

### Kit (supplied in addition to the Swift™ Turbine)

- Aluminium flat roof stand (3 meter pole height with 1 meter squared base plate)
- 16x M10 bolts/steel resin anchors
- 16x RDST rubber AV mounting bushes

\*we advise if there is any doubt about the suitability of the building being mounted to, a structural engineer should be consulted, prior to installation proceeding



### Free-standing Pole Mounting System\*\*

Nationwide pole planting can be arranged through RDST. Suitable access for machinery is required and the area should be clear and level.

The pole will be installed at a 2 meter depth and when installed the SWIFT will project 8 meters tall.

Wiring SWA is typically buried to a minimum depth of 500mm below electrical hazard tape to comply with IEE wiring regulations.

### Flange Mounting System (FMS)

The flange mounting system offers the benefits of a rooftop mounting system with added flexibility. The flange adapter can be fitted to a building adaptor to integrate with the existing structure. The cabling will be routed through the pole and the building adaptor must accommodate this. A round matching flange must be provided with matching hole spacings. The platform the FMS is fixed to must be rigid to avoid vibration and be suitable for the given loads. It is advisable to consult a structural engineer prior to fitting this type of system.



#### Kit (supplied in addition to Swift<sup>TM</sup> Turbine)

- 1.8 meter pole (20kg)
- Flanged adapter (300mm diameter)
- 6 bolts
- 6 sets of rubber AV bushes
- 1 AV rubber gasket



\*\*Ground conditions must be checked before installation can be carried out, RDST cannot be held responsible if installation is not possible due to un-suitable ground conditions





## Masses and wind loadings

In all installation configurations, the chosen RDST mounting system will transmit thrust load from the wind to the supporting structure along with a vertical load due to the weight of the turbine. Loadings and the suitability of the supporting structure to carry them need to be accounted for during the planning stage and if necessary any building modifications approved by a structural engineer prior to installation.

**Any changes to the chosen mounting system will void all warranties.**

The Swift<sup>TM</sup> turbine is designed to safely withstand the wind conditions defined by the appropriate small wind turbine class according to BS61400-2. These classes are defined in terms of wind speed and turbulence parameters. The intention of the classes is to cover most applications. The values of wind speed and turbulence parameters are intended to represent the characteristic values of many different sites and do not give a precise representation of any specific site.

The wind regime for load and safety considerations is divided into the normal wind conditions which will occur frequently during normal operation of a small wind turbine, and the extreme wind conditions which are defined as having a 1 year or 50 year recurrence period. The external conditions to be considered in design are dependent on the intended site.

The Swift<sup>TM</sup> Turbine is Class 2. Wind loadings are based on design wind speeds of:

Small Wind Turbine (SWT) Class 2

- $V_{ref}$  42.5 m/s
- $V_{ave}$  8.5 m/s
- $I_{15}$  0.18

where

- The values apply at hub height
- $I_{15}$  is the dimensionless characteristic value of the turbulence intensity at 15 m/s.



As a guide, when designing the mounting structure, the stresses at the anchor points should be considered to be induced by an axial thrust (acting horizontally at the rotor hub height) as shown in the drawings, plus the loads due to the mass of the turbine and mounting masts. For reference, the approximate mass of the Swift<sup>TM</sup> turbine components are as follows:

Mass of Swift<sup>TM</sup> turbine: 60 kg  
Mass of mounting mast: 55 kg

For further details, please refer to the Technical drawings of mounting systems.

# Key Features: Performance

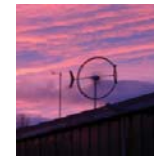

**SWIFT™**  
Wind Energy System

The Swift™ performance data has been verified by the Energy Savings Trust in independent field trials.\*

## Power Curve

A power curve shows the manufacturers predictions of instantaneous power at any given wind speed. To use the power curve, follow the lower axis and locate your estimated wind speed at the site. Then read upwards to see how many watts (W) you can expect from the Swift™ at that minute at that wind speed.

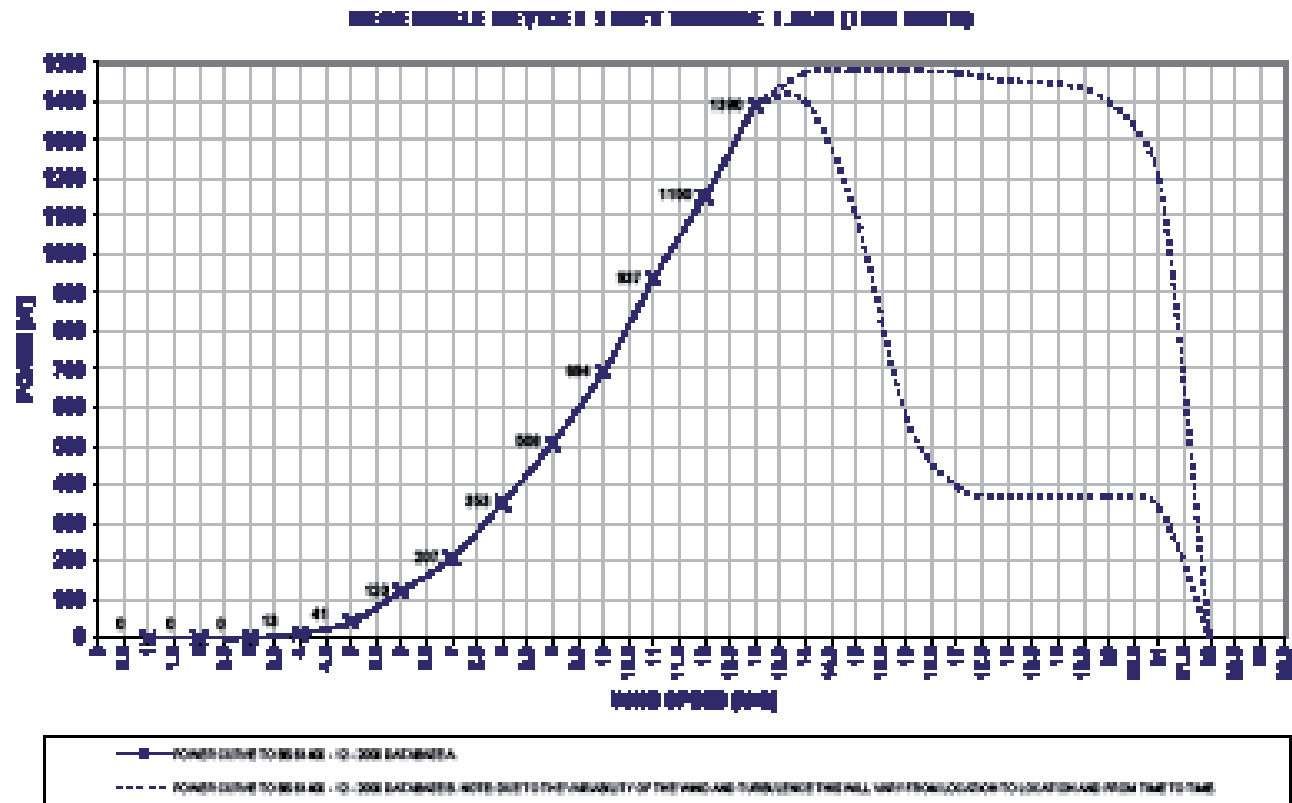

\* EST field trial: Location location location - The Energy Saving Trust's field trial report on domestic wind turbines, EST corporate publications, 09/07/2009. Available at <http://www.energysavingtrust.org.uk/> Measurements were taken at the energy meter (see Electrical connection) and therefore consider the loss of efficiency in each component of the system.

# Estimating Generation

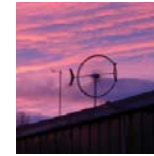

It can be difficult to accurately predict the level of energy you may expect your turbine to generate as the energy yield is directly related to the wind resource at any given site. We suggest that as well as this simple model below you also visit [www.energysavingtrust.org.uk](http://www.energysavingtrust.org.uk) for more detailed information.

Once you have used the graph to account for elevation, the following factors may effect the turbines performance:

- average wind speed
- wind distribution
- turbulence

These 3 fundamental factors are affected by a number of site specifics such as\*:

- Elevation above ground
- Obstacles in the close micro environment (buildings, trees, etc..) particularly in the prevailing wind direction
- Local terrain (top of a hill, bottom of a valley)
- Locality, such as cultivated fields, forest, high trees or urban position

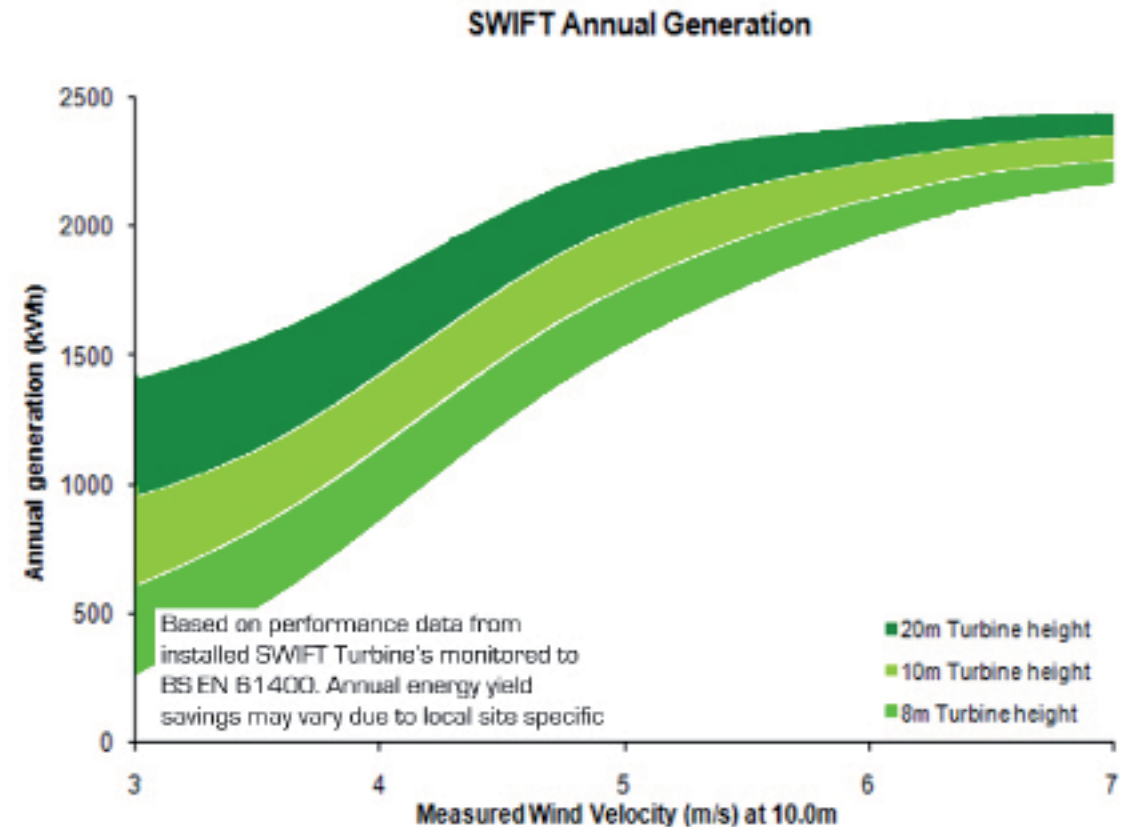

The best way to get an initial approximation of output is to find out the average wind speed at 10m above the ground for the site, and refer to the graph above to adjust for turbine height.

\* other factors may be involved

\*\* The two graphs, on this page and the next, are updated versions dated the 24th of Feb 2010

# Reducing Greenhouse Gasses

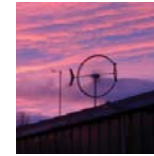

## CO<sub>2</sub> Displacement - Doing your bit

Conventional sources of energy such as coal fired, fuel, or gas power plants releasing CO<sub>2</sub> into the atmosphere for each kWh of electricity generated. Your CO<sub>2</sub> displacement is the CO<sub>2</sub> emission saved when generating a clean kWh from the wind.

In UK 1 kWh of national grid electricity consumed at your house required an average emission of 0.537 kg\* of CO<sub>2</sub>/kWh. Your CO<sub>2</sub> savings are:

$$\text{Energy generated [kWh/year]} \times 0.537 \text{ [kgCO}_2\text{/kWh]} = \text{CO}_2 \text{ saving [kgCO}_2\text{/year]}$$

The graph below shows the levels of CO<sub>2</sub> savings you can expect at various wind speeds with the installation of a Swift™ Wind turbine.

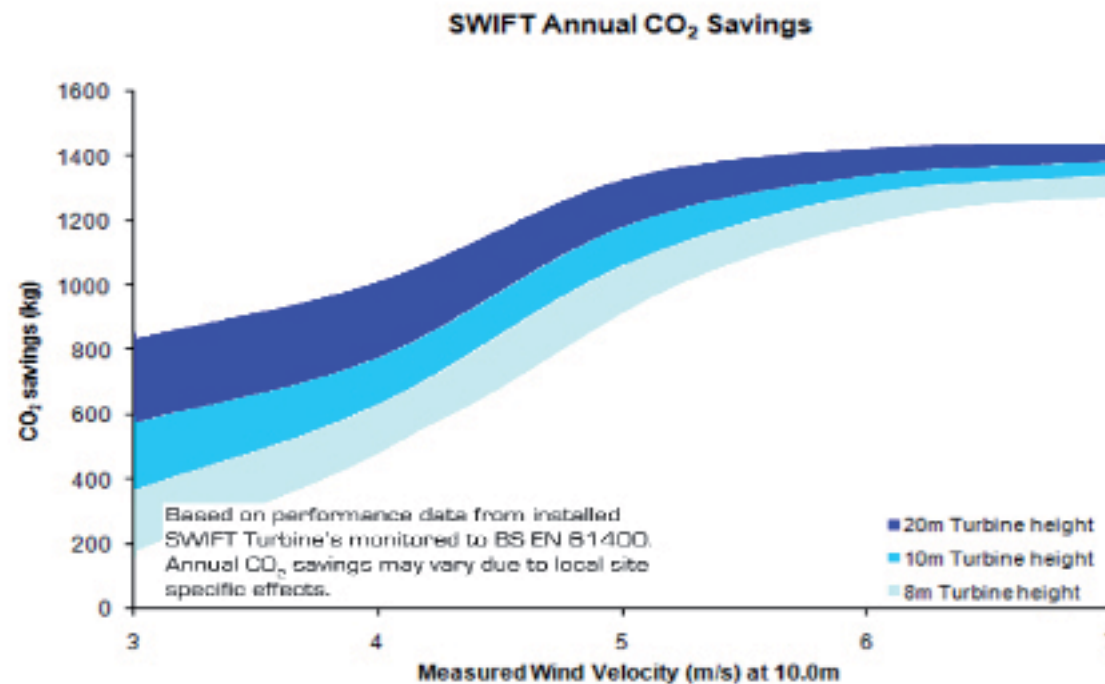

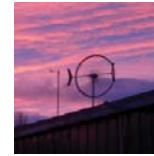

## Further Reading

Technical drawings can be found in the accompanying Technical and Planning Pack Folder, or available upon request.

Website: [www.renewabledevices.com](http://www.renewabledevices.com) - where you will find more information on Renewable Devices Swift Turbines, images and videos of the Swift<sup>TM</sup> and a selection of factsheets currently available to view and download.

## Contact Us

Please feel free to contact us, we will be more than happy to answer any questions you may have:

Renewable Devices Ltd  
Building 10, Turnhouse Aerodrome  
Turnhouse Road  
Edinburgh EH12 9DN

[info@renewabledevices.com](mailto:info@renewabledevices.com)  
+44 (0) 131 339 2247



# Shipping Weights and Sizes

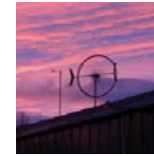

The following are estimated weights and packaging sizes of mast mounted Swift<sup>TM</sup> turbine shipments.







Please note these weights and sizes are subject to change depending on available packaging material

Number of Turbines	Rotor Crate 1	Rotor Crate 2 (if required)	Pallet (if required)	Mounting masts
1	2250x2250x300mm = 25kg		1200x1000x800mm =100kg	5000x100x100mm =45kg
2	2250x2250x300mm =45kg		1200x1000x800mm =200kg	5000x200x150mm =90kg
3	2250x2250x800mm =360kg			5000x200x250mm =135kg
4	2250x2250x800mm =480kg			5000x300x250mm =180kg
5	2250x2250x800mm =600kg			5000x300x250mm =225kg
6	2250x2250x800mm =600kg	2250x2250x300mm =25kg	1200x1000x800mm =100kg	5000x300x350mm =270kg
7	2250x2250x800mm =600g	2250x2250x300mm =45kg	1200x1000x800mm =200kg	5000x400x250mm =315kg
8	2250x2250x800mm =600kg	2250x2250x800mm =360kg		5000x400x350mm =360kg
9	92250x2250x800mm =600kg	2250x2250x800mm =480kg		5000x400x350mm =405kg
10	2250x2250x800mm =600kg	2250x2250x800mm =600kg		500x400x450mm =450kg







# Beaufort Scale

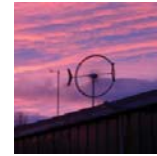

The Beaufort scale is a measure originally designed to describe wind conditions at sea. We have used this scale to help illustrate how the SWIFT system performs at different wind speeds on land.

Beaufort Number		Wind Speed			Description	Observed SWIFT turbine status	SWIFT inverter display status
		m/s	km/h	mph			
0		<0.3	<1	<1	Calm. Smoke rises vertically.	Rotor stationary	Power 0W (Status: * SLEEP)
1		0.3 - 0.5	1-5	1-3	Light air. Wind motion visible in smoke.	Rotor stationary	Power 0W (Status: * SLEEP)
2		1.5- 3.3	6-11	3-7	Light breeze. Leaves rustle.	Rotor starts to spin slowly	Power 0W 'run' light activated (Status: * OK)
3		3.3 - 5.5	12-19	8-12	Gentle breeze. Leaves and smaller twigs in constant motion	Rotor spins, individual blades visible or starting to blur	0-150W
4		5.5 - 8.0	20-28	13-17	Moderate breeze. Dust and loose paper raised.	Rotor facing wind, blades blurred.	50-350W
5		8.0- 10.8	29-38	18-24	Fresh breeze. Small trees begin to sway.	Rotor facing wind, blades blurred.	250-1000W
6		10.8- 13.9	39-49	25-30	Strong breeze. Large branches in motion, whistling heard in wires.	Rotor facing wind, blades blurred.	700-1500W



		<b>m/s</b>	<b>km/h</b>	<b>mph</b>			
7		13.9 - 17.2	50-61	31-38	High wind, near gale. Whole trees in motion, effort needed to walk against the wind.	Turbine starts to furl. Furling fin folds back and turbine starts to turn out of the wind. Occasional electronic braking may occur.	300-1500W
8		17.2 - 20.7	62-74	39-46	Fresh gale. Twigs and small branches break from trees.	Turbine mostly fully furled. Rotor faces 45-90 degrees out of wind.	100-800W
9		20.7 - 24.5	62-74	47-54	Strong gale. Tiles blown from roof.	Turbine fully furled and protected from high winds. Rotor faces up to 90 degrees out of wind. Rotor speed slows.	0-500W
10		24.5 - 28.4	89-102	55-63	Whole gale/storm. Trees are broken or uprooted.	Turbine fully furled. Rotor faces up to 90 degrees out of wind. Rotor speed slow.	0-300W
11		28.4 - 32.6	103-117	64-72	Violent storm. Wide-spread vegetation damage.	Turbine fully furled. Rotor faces up to 90 degrees out of wind. Rotor speed slow.	0-300W
12		>32.6	>118	>73	Hurricane force. Violence and destruction.	Turbine fully furled. Rotor faces up to 90 degrees out of wind. Rotor speed slow.	0-300W



# Notices

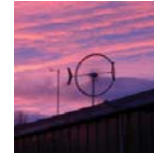

**SWIFT**<sup>TM</sup>  
Wind Energy System

All information contained in this document is believed to be reliable, however, Renewable Devices Swift Turbines Ltd assumes no responsibility for inaccuracies or omissions. The user of the product assumes full risk and responsibility.

All specifications are subject to change without notice.

Wind generator systems must be installed and operated only by registered installers and in accordance with all of the appropriate regulations and manufacturers approved installation and operation procedures.

This document is not an installation manual and is intended for guidance only.

Copyright © 2009 Renewable Devices Swift Turbines Limited, Edinburgh, UK. All rights reserved.

Swift<sup>TM</sup> and Swift Rooftop Wind Energy System<sup>TM</sup> are trademarks of Renewable Devices Swift Turbines Limited.